

FMS6417

Selectable RGB (YUV) HD/SD Video Filter Driver with Y, C, Composite, and Modulator Outputs

Features

- Three channel video reconstruction filter
- YUV/RGB filters
- 2:1 Mux inputs for multiple RGB/YUV inputs
- Selectable 8MHz to 30MHz 6th order filters for RGB (YUV) applications
- 8MHz 6th order Y, C filters with composite summer
- Modulator output with group delay predistortion
- DC coupled input, AC coupled output
- All outputs can drive AC coupled 75Ω loads and provide 6dB of gain
- Dual multiplexed inputs
- 1% differential gain with 1° differential phase
- 36dB/octave roll-off on all channels

Applications

- Cable Set top boxes
- Satellite Set top boxes
- DVD players
- HDTV
- Personal Video Recorders (PVR)
- Video On Demand (VOD)

Description

The FMS6417 offers comprehensive filtering for set top box or DVD applications. This part consists of a triple 6th order filter with selectable 30MHz to 8MHz frequencies and a dual filter for filtering Y,C with a composite summer and a modulator channel with notch and group delay compensation. The modulator provides notching and group delay compensation for NTSC.

2 to 1 multiplexers are provided on the triple filters as well as provisions for auxiliary inputs to the composite channel. The triple filters are intended for either YUV or RGB signals. All channels accept DC coupled ground-referenced 1V_{pp} signals. The filters output 2V_{pp} signals into AC coupled terminated loads. The low-pass filters are powered by 3.3V and the modulator and outputs by 5.0V.

Functional Block Diagram

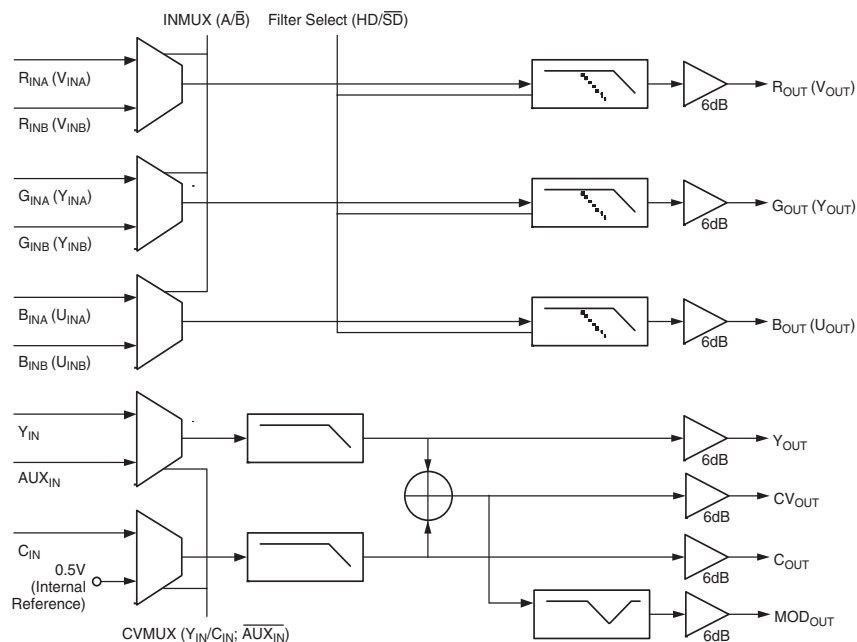

Electrical Specifications

($T_C = 25^\circ\text{C}$, $V_i = 1V_{pp}$, $V_{CCA} = 3.3\text{V}$, $V_{CCO} = 5.0\text{V}$, all inputs DC coupled, all outputs AC coupled; unless otherwise noted)

Symbol	Parameter	Conditions	Min	Typ	Max	Units
I_{CCA}	Supply Current ¹	V_{CCA} no load	50	80	120	mA
I_{CCO}	Supply Current ¹	V_{CCO} no load	10	35	60	mA
I_{CCMOD}	Modulator Supply Current ¹	V_{CCMOD} no load	5	10	15	mA
I_{CCOMOD}	Modulator Supply Current ¹	V_{CCOMOD} no load	10	20	30	mA
V_i	Input Voltage Max	Reference to ground		1.3		V_{pp}
V_{il}	Digital Input Low ¹	F_{SEL} , IN_{MUX} , CV_{MUX}	0		0.8	V
V_{ih}	Digital Input High ¹	F_{SEL} , IN_{MUX} , CV_{MUX}	2.4		V_{CCO}	V
V_{OCV}	Output Voltage	During sync, CV channel		1		V
V_{ORGB}	Output Voltage	During sync, RGB channel		2		V
V_{OMOD}	Output Voltage	During sync, MOD channel		1		V
PSSR	PSSR (all channels)	DC		46		dB

Standard Definition Electrical Specifications

($T_C = 25^\circ\text{C}$, $V_i = 1V_{pp}$, $V_{CCA} = 3.3\text{V}$, $V_{CCO} = 5.0\text{V}$, $F_{SEL} = 0$, all inputs DC coupled, all outputs AC coupled; unless otherwise noted)

Symbol	Parameter	Conditions	Min	Typ	Max	Units
AV_{RGBSD}	RGB SD Gain ¹	R,G,B channels SD Mode	5.3	6.0	6.6	dB
AV_{MOD}	Modulator Gain	MOD channels	5.1	5.8	6.6	dB
f_{1dBSD}	-1dB Bandwidth for SD ¹	R,G,B,Y,C,CV channels	4	5		MHz
f_{CSD}	-3dB Bandwidth for SD	R,G,B,Y,C,CV channels		8		MHz
f_{SBSD}	Attenuation: SD (stopband reject) ¹	R,G,B,Y,C channels at $f = 27\text{MHz}$	37	40		dB
f_{SBCV}	Attenuation: SD (stopband reject) ¹	CV channel at $f = 27\text{MHz}$	37	40		dB
f_{NA}	Notch Attenuation	at 4.425MHz	14	24		dB
MCF	Modulator Channel Flatness	at 3.75MHz	-0.75	0	+0.75	dB
dG	Differential Gain	R,G,B,Y,C,CV channels		1.0		%
$d\phi$	Differential Phase	R,G,B,Y,C,CV channels		1.0		°
$d\phi_{MOD}$	Modulator Differential Phase	MOD channel		1.5		°
THD	Output Distortion (all channels)	$V_{OUT} = 1.8V_{pp}$, Y_{OUT}/C_{OUT} at 3.58MHz		0.4		%
X_{TALKYC}	Crosstalk	channel-to-channel YC		-58		dB
$X_{TALKRGB}$	Crosstalk	channel-to-channel RGB		-65		dB
IN_{MUXISO}	IN_{MUX} Isolation	at 1MHz		-90		dB
SNR	Signal-to-Noise Ratio	R,G,B,Y,C,CV channels, unified weighting, 100kHz highpass enabled		72		dB
t_{pdSD}	Prop Delay for SD	Delay from input to output at 4.5MHz (RGB, YC, CV outputs)		65		ns
Δt_{pdMOD}	Modulator Group Delay	MODE = 0, from 400kHz to 3.58MHz	-230	-170	-130	ns
t_{CLDCV}	Chroma-Luma Delay CV_{OUT}	$f = 3.58\text{MHz}$ (referenced to 400kHz)		6	50	ns
t_{CLGCV}	Chroma-Luma Gain CV_{OUT}	$f = 3.58\text{MHz}$ (referenced to 400kHz)	92	100	104	%

Notes:

- 100% tested at 25°C .

High Definition Electrical Specifications

($T_C = 25^\circ\text{C}$, $V_i = 1V_{pp}$; $V_{CCA} = 3.3V$, $V_{CCO} = 5.0V$, $F_{SEL} = 1$,
all inputs DC coupled, all outputs AC coupled; unless otherwise noted)

Symbol	Parameter	Conditions	Min	Typ	Max	Units
AV_{RGBHD}	RGB HD Gain ¹	R,G,B channels HD Mode	5.3	6.0	6.6	dB
f_{1dBHD}	-1dB Bandwidth for HD ¹	R,G,B channels	16	20		MHz
f_{CHD}	-3dB Bandwidth for HD	R,G,B channels		32		MHz
f_{SBHD}	Attenuation: HD (stopband reject) ¹	R,G,B channels at $f = 74.25\text{MHz}$	25	30		dB
$X_{TALKRGB}$	Crosstalk	channel-to-channel RGB		-68		dB
IN_{MUXISO}	IN_{MUX} Isolation	at 1MHz		-90		dB
SNR	Signal-to-Noise Ratio	R,G,B channels		72		dB
t_{pdHD}	Prop Delay for HD	Delay from input to output at 16MHz		20		ns
Δt_{pdHD}	Group Delay	from 400kHz to 30MHz		5		ns

Absolute Maximum Ratings (beyond which the device may be damaged)

Parameter	Min	Max	Units
DC Supply Voltage	-0.3	7.0	V
Analog and Digital I/O	$V_{SS} - 0.3$	$V_{CC} + 0.3$	V
Output Current RGB Channels ²		120	mA
Output Current CV Channels ²		120	mA
Output Current C,Y Channels ²		120	mA
Junction Temperature		150	$^\circ\text{C}$
Storage Temperature Range	-65	150	$^\circ\text{C}$
Lead Temperature (Soldering, 10s)		260	$^\circ\text{C}$
Thermal Resistance (θ_{JA})		47.9	$^\circ\text{C/W}$

Recommended Operating Conditions

Parameter	Min	Typ	Max	Units
Operating Temperature Range	0		70	$^\circ\text{C}$
V_{CCO} Range ³	4.75	5.0	5.25	V
V_{CCA} Range	3.135	3.3	3.465	V
V_{CCMOD} Range ³	4.75	5.0	5.25	V
V_{CCOMOD} Range ³	4.75	5.0	5.25	V

Notes:

- 100% tested at 25°C .
- Sustained circuit protection limited to 10 seconds.
- V_{CC} , V_{CCMOD} , and V_{CCOMOD} all connected to same supply.

Standard Definition Typical Performance Characteristics

($T_C = 25^\circ\text{C}$, $V_i = 1V_{pp}$; $V_{CCA} = 3.3V$, $V_{CCO} = 5.0V$, $F_{SEL} = 0$, all inputs DC coupled, all outputs AC coupled into 150Ω loads, referenced to 400kHz; unless otherwise noted)

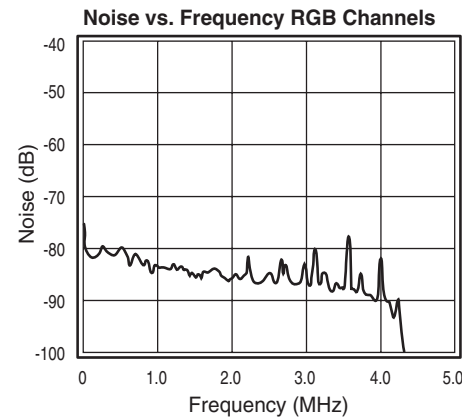
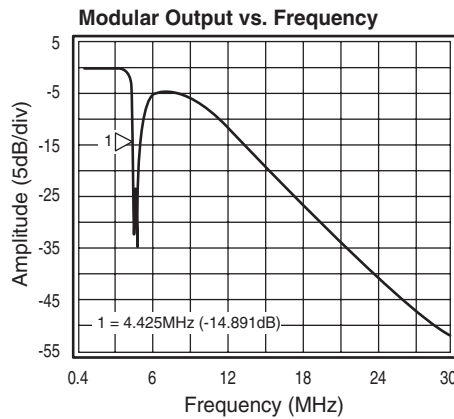
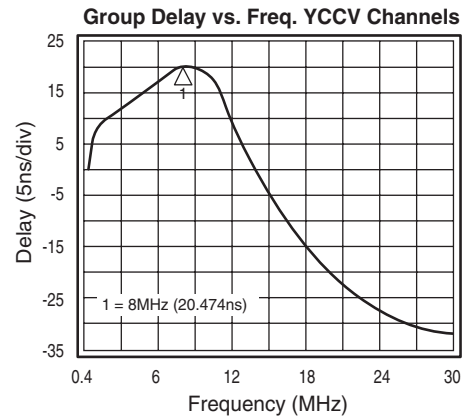
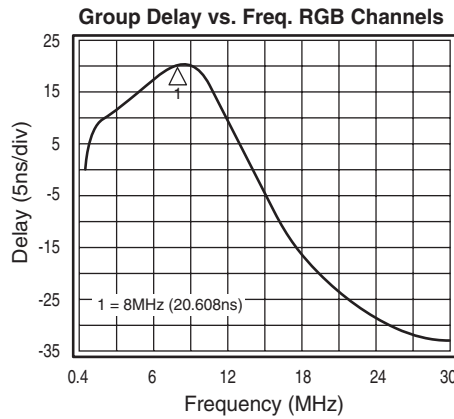
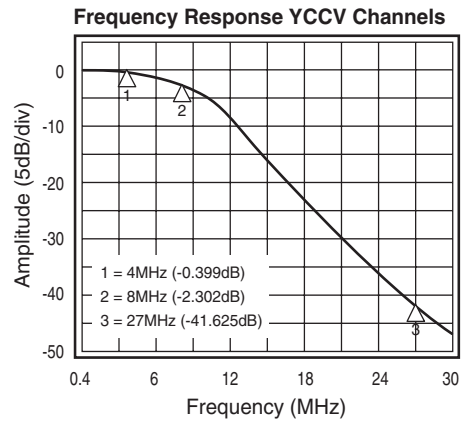
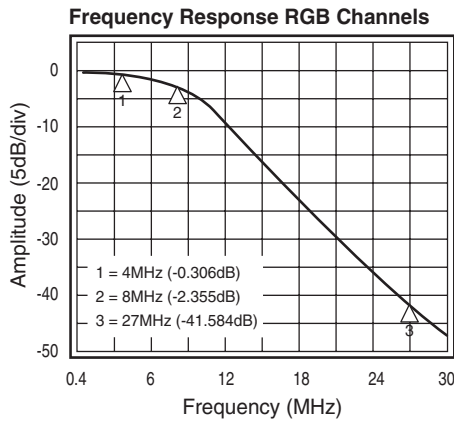

Standard Definition Typical Performance Characteristics

($T_C = 25^\circ\text{C}$, $V_i = 1V_{pp}$; $V_{CCA} = 3.3V$, $V_{CCO} = 5.0V$, $F_{SEL} = 0$, all inputs DC coupled, all outputs AC coupled into 150Ω loads, referenced to 400kHz; unless otherwise noted)

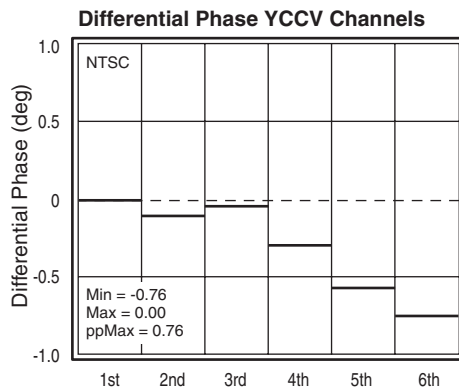
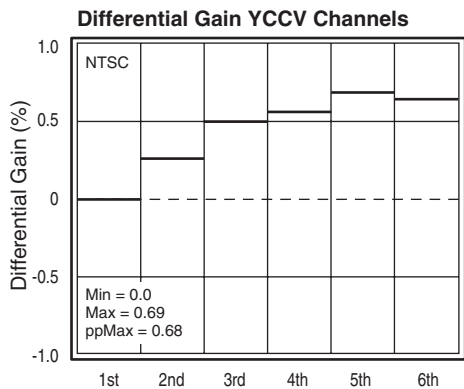
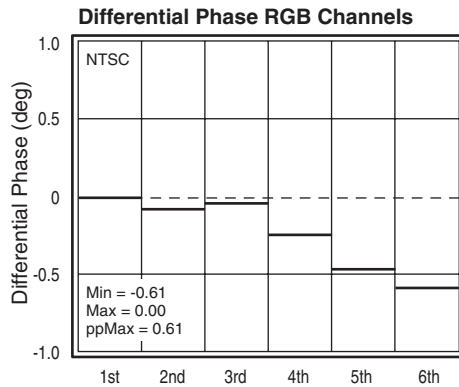
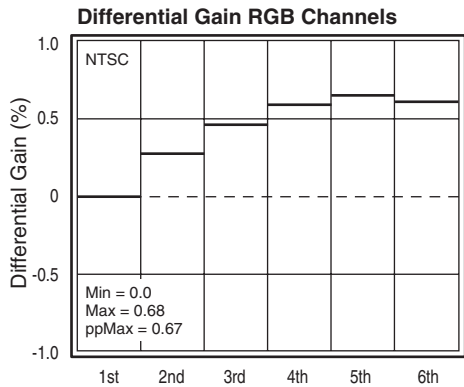
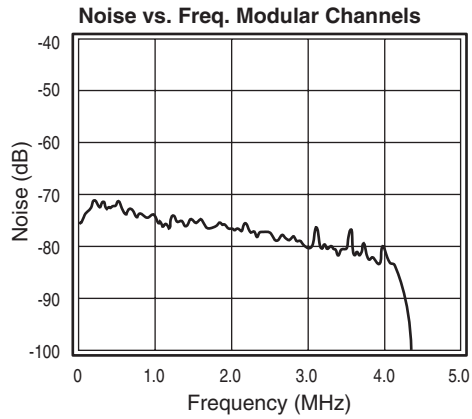
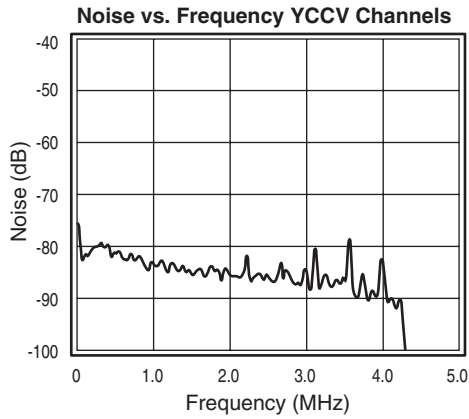

Standard Definition Typical Performance Characteristics

($T_C = 25^\circ\text{C}$, $V_i = 1V_{pp}$; $V_{CCA} = 3.3V$, $V_{CCO} = 5.0V$, $F_{SEL} = 0$, all inputs DC coupled, all outputs AC coupled into 150Ω loads, referenced to 400kHz; unless otherwise noted)

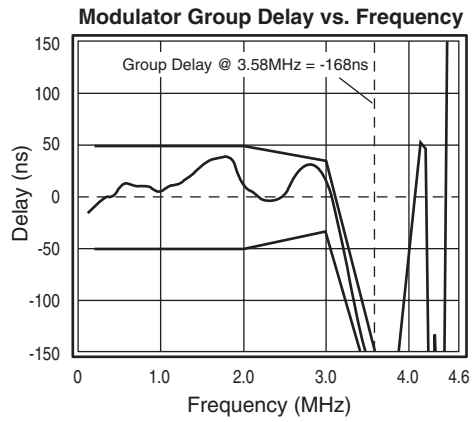
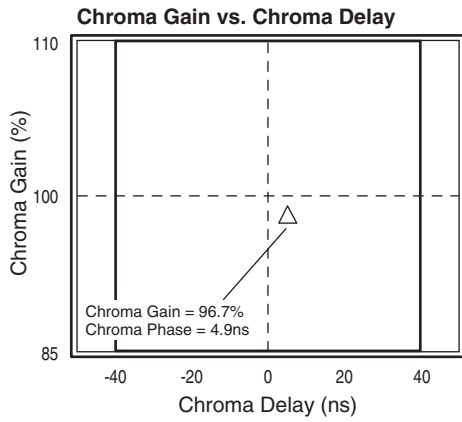

High Definition Typical Performance Characteristics

($T_C = 25^\circ\text{C}$, $V_i = 1V_{pp}$; $V_{CCA} = 3.3V$, $V_{CCO} = 5.0V$, $F_{SEL} = 1$, all inputs DC coupled, all outputs AC coupled into 150Ω loads, referenced to 400kHz; unless otherwise noted)

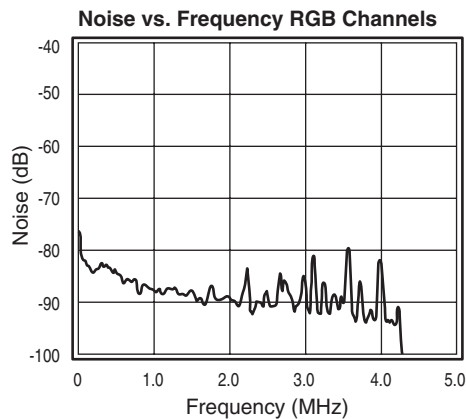
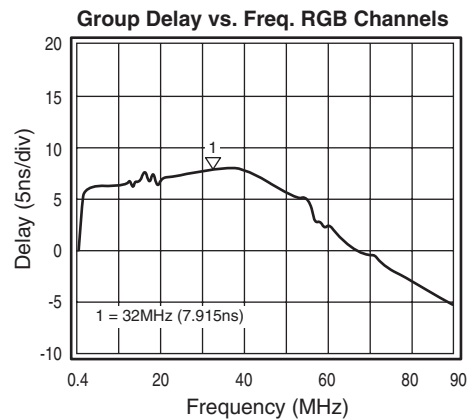
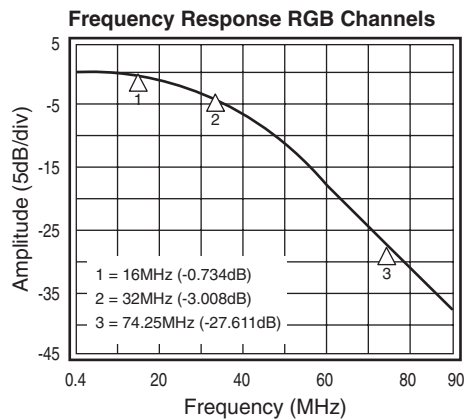

General Description

The FMS6417 offers comprehensive filtering for set top box or DVD applications. This part consists of a triple 6th order filter with selectable 30MHz to 8MHz frequencies and a dual filter for filtering Y,C with a composite summer and a modulator channel with notch and group delay compensation. The modulator provides notching and group delay compensation for NTSC. 2 to 1 multiplexers are provided on the triple filters as well as provisions for auxiliary inputs to the composite channel. The triple filters are intended for either YUV or RGB signals. All channels accept DC coupled ground-referenced $1V_{pp}$ signals. The filters output $2V_{pp}$ signals into AC coupled terminated loads. The low-pass filters are powered by 3.3V and the modulator and outputs by 5.0V.

The FMS6417 is a next generation filter solution from Fairchild Semiconductor, addressing the expanding filtering needs for set top boxes, and DVD players. The product provides selectable filtering from 30MHz to 8MHz on the RGB channels. Thus, the FMS6417 addresses the requirement for a single set top box to be compatible with a variety

of resolution standards. Additionally, the product provides additional filters for Y, C, CV, and modulator outputs. Multiplexers on the RGB and CV channel provide further flexibility.

For DVD applications, the product provides filtering and output drive amplification for 7 channels of outputs. These include R, G, B, Y, C, CV, and modulator outputs.

For set top boxes, this product provides for 2 channels of video to be filtered, as well as the flexibility of selectable high order filtering for multiple resolution standards. Additional flexibility is provided by the additional Y,C filters with composite summers.

All channels provide 6dB gain, accept $1V$ ground referenced inputs, and drive AC coupled loads. The filters for the R, G, B, Y, C, and CV channels are powered from a 3.3V supply and the modulator channel and outputs from 5V.

The modulator channel has notch and group delay compensation set for NTSC specifications.

Applications

Typical Application Diagram

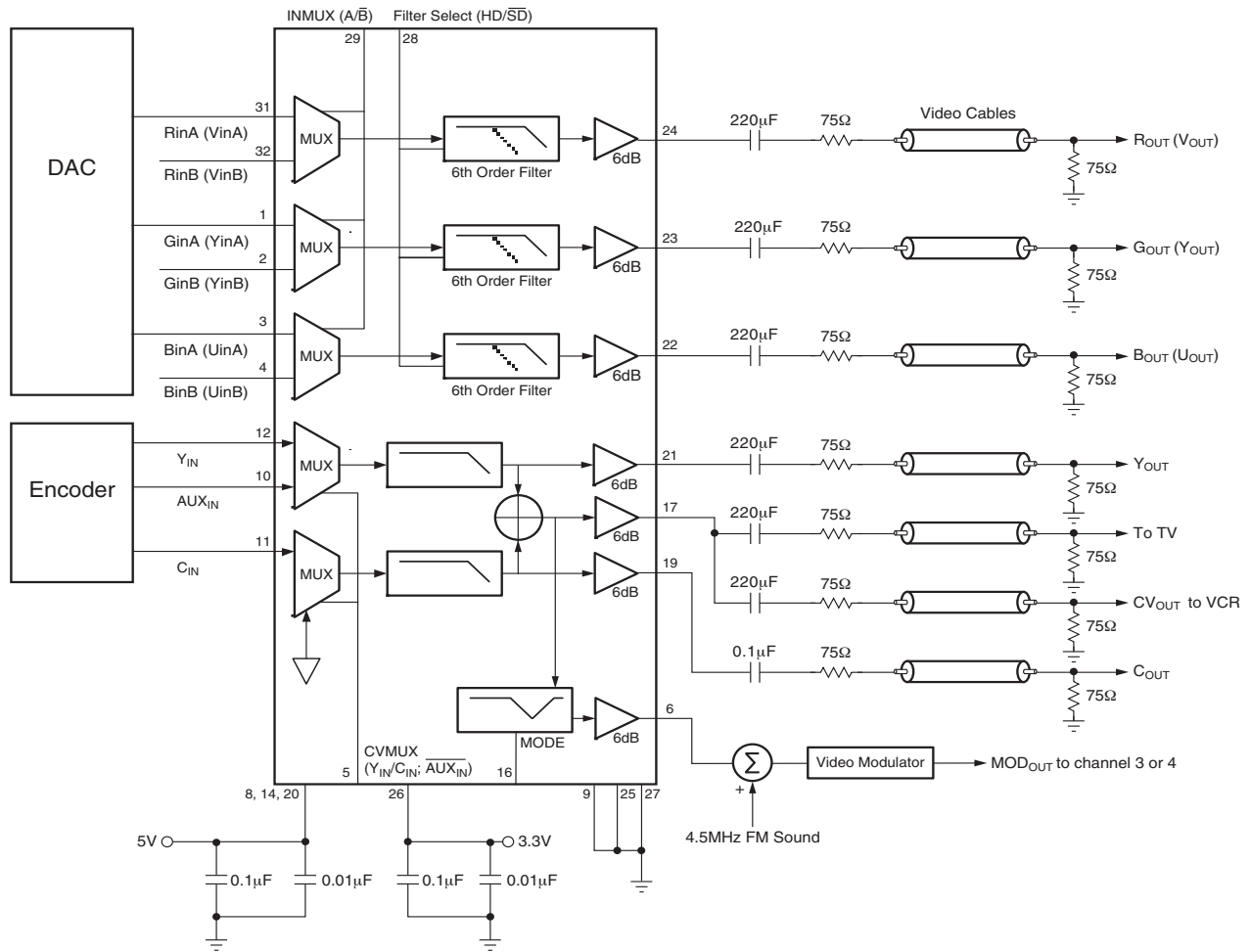

Pin Configuration

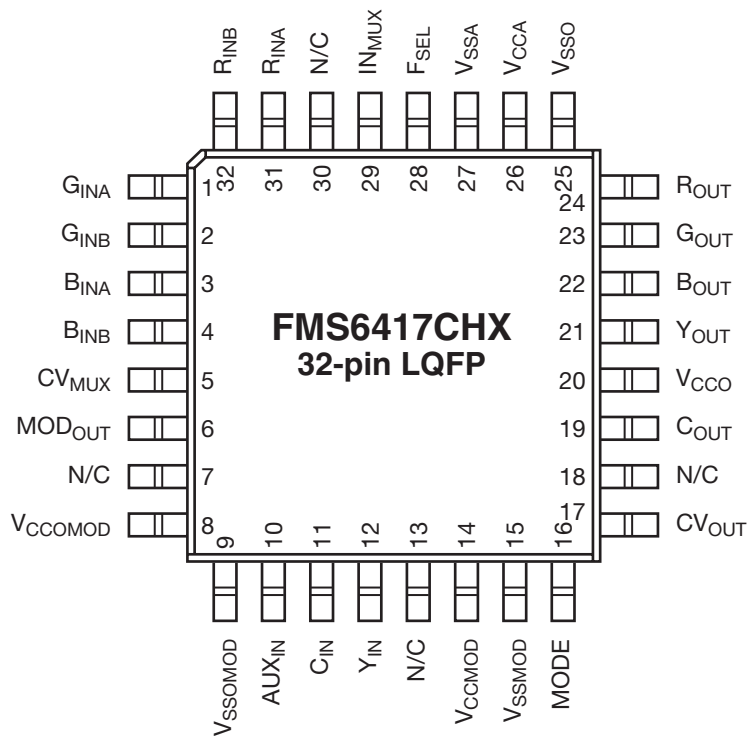

Pin Assignments

Pin #	Pin Name	Description
1	G _{INA}	Analog GREEN video input for Channel <A>
2	G _{INB}	Analog GREEN video input for Channel
3	B _{INA}	Analog BLUE video input for Channel <A>
4	B _{INB}	Analog BLUE video input for Channel
5	CV _{MUX}	Logic input pin selects between the Y _{IN} (1) or AUX _{IN} (0) inputs as well as enabling or disabling C _{IN}
6	MOD _{OUT}	Modulator output
7	N/C	No connect
8	V _{CCMOD}	5V V _{CC} for modulator output buffers
9	V _{SSOMOD}	Ground for modulator output buffers
10	AUX _{IN}	Filtered analog composite video or luma input
11	C _{IN}	Chrominance (Chroma) input
12	Y _{IN}	Luminance (Luma) input
13	N/C	No connect
14	V _{CCMOD}	V _{CC} for modulator
15	V _{SSMOD}	Ground for modulator

Pin Assignments (Continued)

Pin #	Pin Name	Description
16	MODE	Set group delay mode for NTSC. Set to 0.
17	CV _{OUT}	Composite video output
18	N/C	No connect
19	C _{OUT}	Chrominance (Chroma) output
20	V _{CCO}	5V power supply for output buffers of the RGB and CV drivers
21	Y _{OUT}	Luminance (Luma) output
22	B _{OUT}	Filtered analog BLUE video output from either B _{INA} or B _{INB}
23	G _{OUT}	Filtered analog GREEN video output from either G _{INA} or G _{INB}
24	R _{OUT}	Filtered analog RED video output from either R _{INA} or R _{INB}
25	V _{SSO}	Ground for output buffers
26	V _{CCA}	V _{CC} analog 3.3V supply
27	V _{SSA}	Analog ground
28	F _{SEL}	Select between (0) SD (8.0MHz) and (1) HD (30.0MHz) filters
29	IN _{MUX}	Logic input selects between Channel <A> (1) or (0) of the RGB inputs. Internally pulled high.
30	N/C	No connect
31	R _{INA}	Analog RED video input for Channel <A>
32	R _{INB}	Analog RED video input for Channel

Package Dimensions

LQFP-32

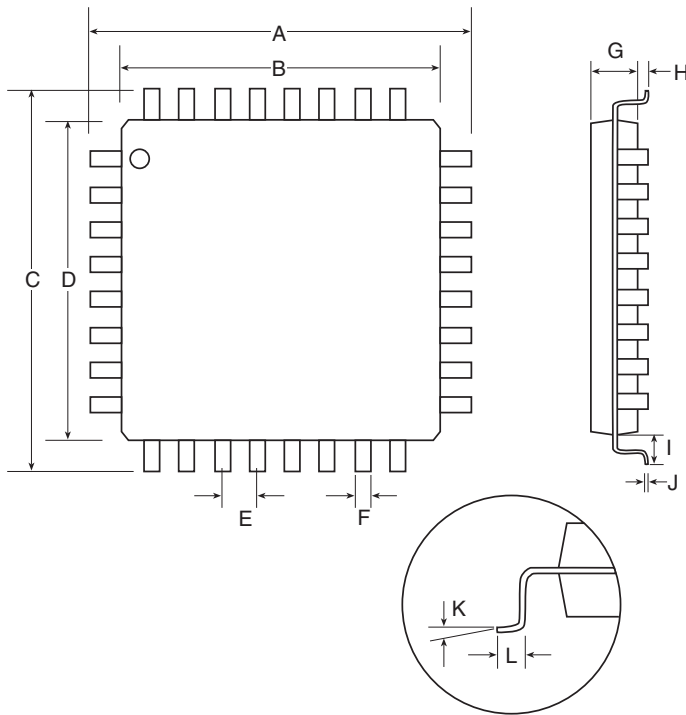

MILLIMETERS		
Symbol	Min	Max
A	8.80	9.20
B	6.90	7.10
C	8.80	9.20
D	6.90	7.10
E	0.80 BSC	
F	0.30	0.47
G	1.35	1.45
H	0.05	0.15
I	0.95	1.05
J	0.09	0.2
K	0°	7°
L	0.45	0.75

Ordering Information

Model	Part Number	Package	Container	Pack Qty
FMS6417	FMS6417CH	32-pin LQFP	Tray	250
FMS6417	FMS6417CHX	32-pin LQFP	Tape & Reel	1,000

Temperature range for all parts: 0°C to +70°C.

DISCLAIMER

FAIRCHILD SEMICONDUCTOR RESERVES THE RIGHT TO MAKE CHANGES WITHOUT FURTHER NOTICES TO ANY PRODUCTS HEREIN TO IMPROVE RELIABILITY, FUNCTION OR DESIGN. FAIRCHILD DOES NOT ASSUME ANY LIABILITY ARISING OUT OF THE APPLICATION OR USE OF ANY PRODUCT OR CIRCUIT DESCRIBED HEREIN; NEITHER DOES IT CONVEY ANY LICENSE UNDER ITS PATENT RIGHTS, NOR THE RIGHTS OF OTHERS.

LIFE SUPPORT POLICY

FAIRCHILD'S PRODUCTS ARE NOT AUTHORIZED FOR USE AS CRITICAL COMPONENTS IN LIFE SUPPORT DEVICES OR SYSTEMS WITHOUT THE EXPRESS WRITTEN APPROVAL OF THE PRESIDENT OF FAIRCHILD SEMICONDUCTOR CORPORATION. As used herein:

1. Life support devices or systems are devices or systems which, (a) are intended for surgical implant into the body, or (b) support or sustain life, and (c) whose failure to perform when properly used in accordance with instructions for use provided in the labeling, can be reasonably expected to result in a significant injury of the user.
2. A critical component in any component of a life support device or system whose failure to perform can be reasonably expected to cause the failure of the life support device or system, or to affect its safety or effectiveness.